

NEON FLEX TUBE

Top View Series

SPEC SHEET

Features

- Save up to 90% of energy costs over glass neon
- Extremely bright
- Highly flexible
- Cool to the touch
- Easy to install
- Strip PCB 10mm
- Weight:55g/M

NT1305

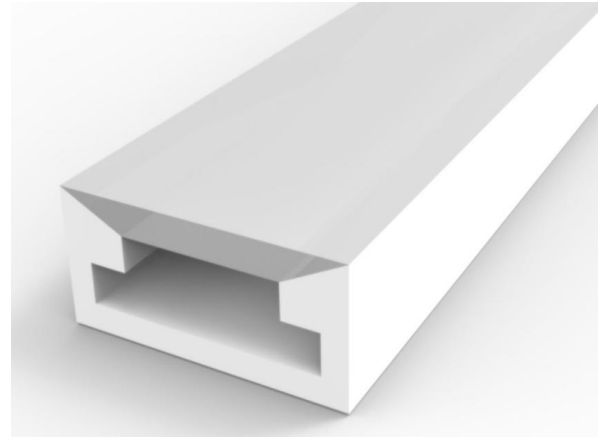

Dimensions / mm

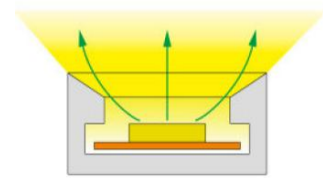
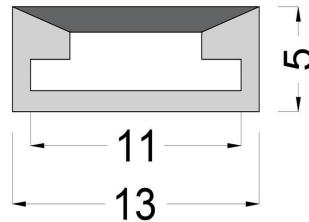
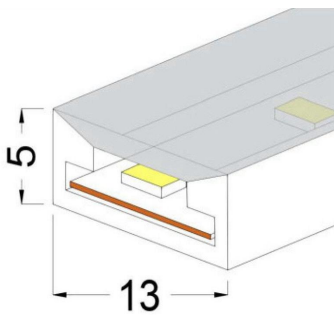

Accessories

Wire Caps	Right wire cap	Left wire cap	Bottom wire cap	Straight wire cap
PIC				

Item	End cap	Installation clip	Aluminum channel	Glue
PIC				